



# Leica TM6100A

## User Manual

Version 1.0  
English

- when it has to be **right**

*Leica*  
Geosystems

---

## Introduction

---

### Purchase

Congratulations on the purchase of a TM6100A instrument.

---



This manual contains important safety directions as well as instructions for setting up the product and operating it. Refer to "6 Safety Directions" for further information.



Read carefully through the User Manual before you switch on the product.

---

### Product identification

The type and the serial number of your product are indicated on the type plate. Enter the type and serial number in your manual and always refer to this information when you need to contact your agency or Leica Geosystems authorized service workshop.





Type: \_\_\_\_\_

Serial No.: \_\_\_\_\_

---

## Symbols

The symbols used in this manual have the following meanings:

Type	Description
 <b>Danger</b>	Indicates an imminently hazardous situation which, if not avoided, will result in death or serious injury.
 <b>Warning</b>	Indicates a potentially hazardous situation or an unintended use which, if not avoided, could result in death or serious injury.
 <b>Caution</b>	Indicates a potentially hazardous situation or an unintended use which, if not avoided, may result in minor or moderate injury and/or appreciable material, financial and environmental damage.
	Important paragraphs which must be adhered to in practice as they enable the product to be used in a technically correct and efficient manner.

## Trademarks



- CompactFlash and CF are trademarks of SanDisk Corporation
- Bluetooth is a registered trademark of Bluetooth SIG, Inc



All other trademarks are the property of their respective owners.

## Validity of this manual

	Description
<b>General</b>	This manual applies to all TM6100A instruments.

**Available  
documentation**

<b>Name</b>	<b>Description and Format</b>		
User Manual	All instructions required in order to operate the product to a basic level are contained in the User Manual. Provides an overview of the product together with technical data and safety directions.	✓	✓

<b>Name</b>	<b>Description and Format</b>		
System Field Manual	Describes the general working of the product in standard use and specific onboard application programs. Intended as a quick reference field guide.	✓	✓
Technical Reference Manual	Overall comprehensive guide to the product and program functions. Included are detailed descriptions of special software/hardware settings and software/hardware functions intended for technical specialists.		✓

**Refer to the following resources for all TM6100A documentation and software**

- the TPS6000 Product CD
- [http://metrology.leica-geosystems.com/en/Downloads\\_6843.htm](http://metrology.leica-geosystems.com/en/Downloads_6843.htm)

# Table of Contents

---

In this manual	Chapter	Page
	<b>1 Description of the System</b>	<b>8</b>
	1.1 System Components	8
	1.2 System Concept	11
	1.2.1 Software Concept	11
	1.2.2 Data Storage and Data Conversion Concept	13
	1.2.3 Power Concept	15
	1.3 Container Contents	16
	1.4 Instrument Components	17
	<b>2 User Interface</b>	<b>20</b>
	2.1 Keyboard	20
	2.2 Hot Key Assignments	24
	2.3 Screen	27
	2.4 Operating Principles	29
	2.5 Icons	35
	<b>3 Operation</b>	<b>37</b>
	3.1 Instrument Setup	37
	3.2 Battery	40
	3.2.1 Operating Principles	40

---

3.2.2	Instrument Battery	41
3.3	Working with the CompactFlash Card	43
3.4	Accessing Survey Application Program	46
3.5	Built-in autocollimation device	49
3.6	Connection to Application Computer	51
3.7	Limitation of the horizontal and vertical movements	55
<b>4</b>	<b>Check &amp; Adjust</b>	<b>60</b>
<hr/>		
4.1	Overview	60
4.2	Preparation	63
4.3	Combined Adjustment (l, t, i and c)	65
4.4	Tilting Axis Adjustment (a)	69
4.5	Adjusting the Circular Level of the Instrument and Tribrach	74
4.6	Adjusting the Circular Level of the Prism Pole	76
4.7	Inspecting the Laser Plummet of the Instrument	77
4.8	Servicing the Tripod	79
4.9	Adjustment of the autocollimation reticule	80
<b>5</b>	<b>Care and Transport</b>	<b>82</b>
<hr/>		
5.1	Transport	82
5.2	Storage	84
5.3	Cleaning and Drying	85
5.4	Maintenance	87

<b>6</b>	<b>Safety Directions</b>	<b>88</b>
6.1	General Introduction	88
6.2	Intended Use	89
6.3	Limits of Use	91
6.4	Responsibilities	92
6.5	Hazards of Use	93
6.6	Laser Classification	99
	6.6.1 General	99
	6.6.2 Laser Plummet	101
6.7	Electromagnetic Compatibility EMC	104
6.8	FCC Statement, Applicable in U.S.	107
<b>7</b>	<b>Technical Data</b>	<b>110</b>
7.1	Angle Measurement	110
7.2	Conformity to National Regulations	111
	7.2.1 Communication side cover with Bluetooth	111
7.3	General Technical Data of the Instrument	112
<b>8</b>	<b>International Limited Warranty, Software License Agreement</b>	<b>119</b>

# 1 Description of the System

## 1.1 System Components

### Main components

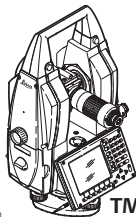

TM6100A\_001

**TM6100A**

Component	Description
TM6100A	<ul style="list-style-type: none"><li>• an instrument of highest accuracy for measuring, calculating and capturing data.</li><li>• connected with LGO Tools to view, exchange and manage data.</li></ul>
Application Software	Third party metrology software with an interface to the TM6100A for acquisition, analysis, management and reporting of data.
LGO Tools	An office software consisting of a suite of standard and extended programs for the viewing, exchange and management of data.



## Terminology

The following terms and abbreviations may be found in this manual:

<b>Term</b>	<b>Description</b>
TPS	<b>T</b> otal <b>S</b> tation <b>P</b> ositioning <b>S</b> ystem
LGO Tools	<b>L</b> EICA <b>G</b> eo <b>O</b> ffice Tools
Motorised	TM6100A instruments are fitted with internal motors, enabling automatic horizontal and vertical turning are referred to as <b>M</b> otorised.
Communication side cover	Communication side cover with integrated Bluetooth is a component with external devices, i.e. laptop with application software.

**Instrument models**

Model	Description
TM6100A	Electronic theodolite, motorised, 0.5" accuracy.

**LEICA Geo Office Tools**

- LGO Tools supports TM6100A instruments. It also supports all other Leica TPS instruments.
- LGO Tools is based on a graphical user interface with standard Windows® operating procedures.
- LGO Tools provides the following functionality:

Functionality	Description
Standard Functionality	Includes data exchange between computer and instrument, data management including viewing and editing, reporting, creation and management of codelists, creation and use of format files for data conversion, uploading and deleting of system software and application programs.

- Supported operating systems: Windows® XP, Windows® 2000.
- Refer to the online help of LGO Tools for additional information.

## 1.2

## System Concept

### 1.2.1

### Software Concept

---

#### Description

TM6100A instruments support the following types of software.

---

#### Software type

Software type	Description
System software	<p>This software comprises the central functions of the instrument. It is also referred to as firmware.</p> <p>The programs Survey and Setup are integrated into the firmware and cannot be deleted.</p> <p>The English language is integrated into the firmware and cannot be deleted.</p>
Language software	<p>Numerous languages are available for the TM6100A instruments. This software is also referred to as system language.</p> <p>The system software enables a maximum of three languages which can be stored at any one time - the English language and two other languages. The English language is the default language and cannot be deleted. One language is chosen as the active language.</p>

---

Software type	Description
Application programs	A suite of optional specific application programs are available for the instrument.  Some of the programs are activated freely and require no license key and others require purchasing and are only activated with a license key.
Third party application programs	There are various third party applications available for the TM6100A, onboard or computer based software. Please contact your Leica Geosystems representative for details.
Customised application programs	Customised software specific to user requirements can be developed using the GeoC++ development kit. Information on the GeoC++ development environment is available on request from a Leica Geosystems representative.

---

### Software upload

All instrument software is stored in the System RAM of the instrument. The software can be uploaded onto the instrument using the following methods:

- Using LGO Tools the software is transferred via the serial interface to the CompactFlash card in the instrument, which is then stored to the System RAM.
  - By connecting the CompactFlash card directly to the computer either via an internal card slot housing or an external OMNI drive, the software is transferred to the card, which is then stored to the System RAM.
-

## 1.2.2

## Data Storage and Data Conversion Concept

---

### Description

Data is stored within a job in a database on a memory device. This is either a CompactFlash card or an internal memory.

---

### Memory device

CompactFlash card:

A CompactFlash card housing is standard. A CompactFlash card can be inserted and removed. Available capacity: 256 MB and 1 GB.



Whilst other CompactFlash cards may be used, Leica recommends Leica CompactFlash cards and cannot be held responsible for data loss or any other error that may occur when using a non-Leica card.

Internal memory:

An internal memory is always fitted. It resides inside the instrument. Available capacity: 256 MB.

---



Unplugging connecting cables or removing the CompactFlash card during the measurement may cause loss of data. Always return to **TM6100A Main Menu** before removing the CompactFlash card and switch off the instrument before removing cables.

---

**Data conversion****Export**

Data can be exported from a job in a wide range of ASCII formats. A standard set of Export Formats is delivered with the system. Customized export format can defined in Format Manager which is a PC tool in LEICA Geo Office Tools. Refer to the online help of LGO Tools for information on creating format files.

Data can also be exported from a job in DXF or LandXML format.

**Import**

Data can be imported from ASCII, DXF, GSI8 or GSI16 format.

**Transfer raw data  
to LGO Tools**

Raw data can be transferred between the database on the CompactFlash card or the internal memory of the instrument and LGO Tools in two ways:

- From the CompactFlash card or the internal memory directly via a serial interface to a project in LGO Tools on a PC.
- From the CompactFlash card using for example an OMNI drive as supplied by Leica Geosystems to a project in LGO Tools on a PC.



CompactFlash cards can be used directly in an OMNI drive as supported by Leica Geosystems. Other PC card drives may require an adapter.

### 1.2.3

## Power Concept

---

#### General

Use the Leica Geosystems batteries, chargers and accessories or accessories recommended by Leica Geosystems to ensure the correct functionality of the instrument.

---

#### Power options

##### Instrument

Power for the instrument can be supplied either internally or externally. An external battery is connected to the instrument using a LEMO cable.

Internal battery:            One GEB241 battery fitted into the battery compartment.

External battery:            One GEB171 battery connected via cable

## 1.3 Container Contents

### Container for instrument and delivered accessories

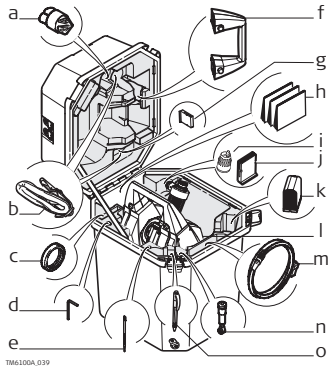

- a) Protective cover for instrument and sunshade for objective lens
- b) Container straps
- c) Counterweight for diagonal eyepiece or zenith eyepiece - optional
- d) Allen key
- e) Spare stylus
- f) Room for normal handle
- g) Compact Flash card with cover
- h) User manual
- i) Autocollimation lamp AL51 - optional
- j) CompactFlash card adapter with cover - optional
- k) Internal battery GEB241 - optional
- l) Instrument with supplied stylus and tribrach
- m) Data transfer cable GEV218 - optional
- n) Diagonal eyepiece GFZ3 or zenith eyepiece GOK6 (eyepiece for steep sighting) - optional
- o) Ball pen - optional



## 1.4

## Instrument Components

### Instrument components part 1 of 2

The instrument components of a TM6100A instrument are shown below.

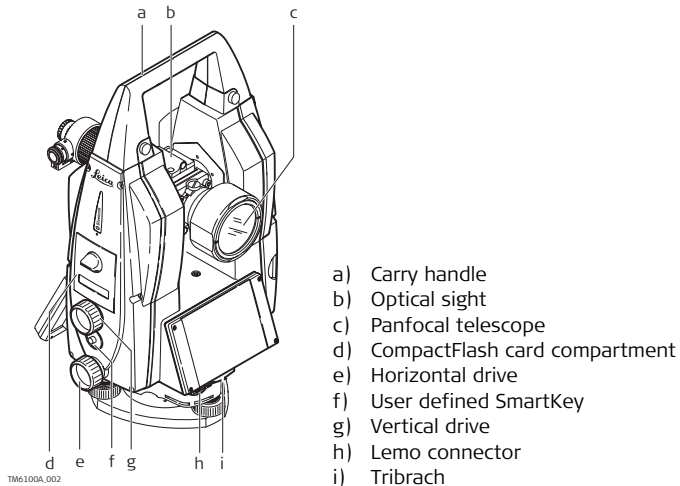

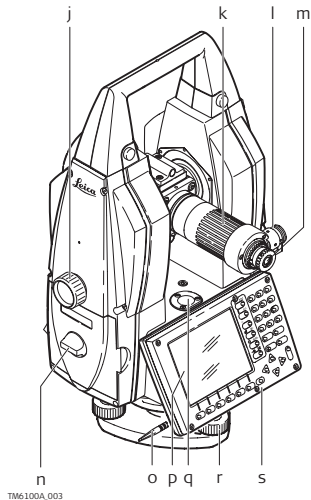
**Instrument  
components  
part 2 of 2**

TM6100A\_003

- j) Vertical drive
- k) Focusing ring
- l) Autocollimation device
- m) Interchangeable eyepiece
- n) Battery compartment
- o) Stylus for touch screen
- p) Screen
- q) Circular level
- r) Footscrew
- s) Keyboard

## Internal target

An internal target GUS29 may be factory fitted to the telescope of the TM6100A to facilitate the mutual accurate collimation of two theodolites. Depending on the measurement task, the internal target can be rotated into or out of position.

---

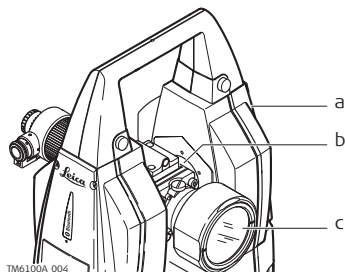

- a) TM6100A
- b) Knob to rotate internal target GUS29
- c) Panfocal telescope



The internal target GUS29 is rotated into the visible positions when the marker line on the knob is perpendicular to the line of sight. When the marker line on the knob is parallel to the line of sight, the internal target GUS29 is out of sight.

---

## 2 User Interface

### 2.1 Keyboard

#### Keyboard

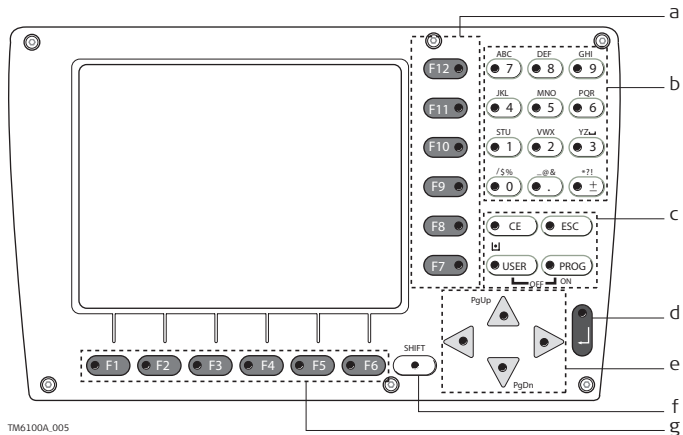

- a) Hot keys **F7-F12**
- b) Alphanumeric keys
- c) **CE, ESC, USER, PROG**
- d) **ENTER**
- e) Arrow keys
- f) **SHIFT**
- g) Function keys **F1-F6**

## Keys

Key	Description
Hot keys <b>F7-F12</b>  	<ul style="list-style-type: none"> <li>• Pre-defined keys to execute commands or access chosen screens.</li> <li>• The hot key F13, the user defined SmartKey, is located between the horizontal and vertical drive on the right hand side cover.</li> </ul>
Alphanumeric keys	<ul style="list-style-type: none"> <li>• To type letters and numbers.</li> </ul>
<b>CE</b>	<ul style="list-style-type: none"> <li>• Clears all entry at the beginning of user input.</li> <li>• Clears the last character during user input.</li> </ul>
<b>ESC</b>	<ul style="list-style-type: none"> <li>• Leaves the current menu or dialog without storing changes made.</li> </ul>
<b>USER</b>	<ul style="list-style-type: none"> <li>• Calls the user defined menu.</li> </ul>
<b>PROG (ON)</b>	<ul style="list-style-type: none"> <li>• If the instrument is off: to turn instrument on.</li> <li>• If the sensor is on: press at any time to select an application program.</li> </ul>

---

Key	Description
<b>ENTER</b>	<ul style="list-style-type: none"><li>• Selects the highlighted line and leads to the next logical dialog/menu.</li><li>• Starts the edit mode for edit fields.</li><li>• Opens a list box.</li></ul>
<b>SHIFT</b>	<ul style="list-style-type: none"><li>• Changes between the first and the second level of function keys.</li></ul>
<b>Arrow</b> keys	<ul style="list-style-type: none"><li>• Move the focus on the screen.</li></ul>
Function keys <b>F1-F6</b>	<ul style="list-style-type: none"><li>• Correspond to the six softkeys that appear on the bottom of the screen when the screen is activated.</li></ul>

---

## Key combinations

Keys	Description
<b>PROG</b> plus <b>USER</b>	Turns instrument off.
<b>SHIFT F12</b>	Calls <b>STATUS Level &amp; Laser Plummet</b> .
<b>SHIFT F11</b>	Calls <b>CONFIGURE Lights, Display, Beeps, Text, Lights</b> page.
<b>SHIFT USER</b>	Calls <b>QUICK SET Change Settings to:</b> .
<b>SHIFT ▲</b>	Pages up.
<b>SHIFT ▼</b>	Pages down.

---

## 2.2 Hot Key Assignments

### General

TM6100A instruments contain two standard configurations at delivery. Two more configurations are available on the Factory CD.

Configuration Set	Description	Angle Unit
TM6100A BT	Standard configuration set for Bluetooth connection	Degree
TM6100A Cable	Standard configuration set for Cable connection	Degree



## Hot Keys

All default configurations contain the following Hot Key & Shift Hot Key assignments:

Key	Description
F7	Autocollimation lamp On/Off
F8	Reticule illumination On/Off
F9	Change face
F10	Position Hz/V
F11	TPS Correction (Environmental Parameters)
F12	Check & Adjust
F13 (Trigger Key)	Rec (Take an angle measurement)
Shift - F7	Compensator functions
Shift - F8	Telescope accessories
Shift - F9	Units & Formats
Shift - F10	Battery & Memory Status
Shift - F11	Lights & Display Settings
Shift - F12	Electronic Level & Plummet

**Keyboard Overlay**

A self adhesive keyboard overlay is available for the default Hot Key assignments. The keyboard overlay can be affixed to the keyboard as shown below if required.

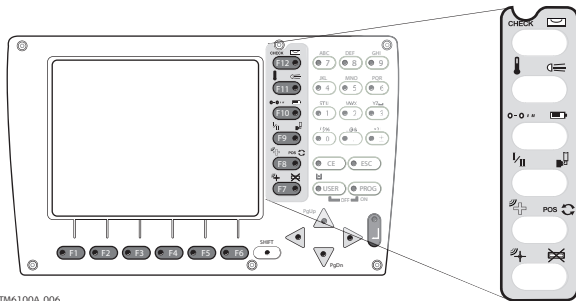

TM6100A\_006

## 2.3

## Screen

### Screen

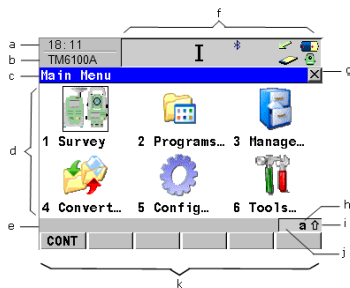

5\_TDRAG000\_001

- a) Time
- b) Caption
- c) Title
- d) Screen area
- e) Message line
- f) Icons
- g) ESC ☒
- h) CAPS
- i) SHIFT icon
- j) Quick coding icon
- k) Softkeys

### Elements of the screen

Element	Description
Time	The current local time is shown.
Caption	Shows location either in <b>Main Menu</b> , under <b>PROG</b> key or <b>USER</b> key.
Title	Name of the screen is shown.
Screen area	The working area of the screen.

---

Element	Description
Message line	Messages are shown for 10 s.
Icons	Shows current status information of the instrument. Refer to "2.5 Icons". Can be used with touch screen.
ESC 	Can be used with touch screen. Same functionality as the fixed key <b>ESC</b> . The last operation will be undone.
CAPS	The caps mode for upper case letters is active. The caps mode is activated and deactivated by pressing <b>UPPER (F5)</b> or <b>LOWER (F5)</b> in some screens.
SHIFT icon	Shows the status of the <b>SHIFT</b> key; either first or second level of softkeys is selected. Can be used with touch screen and has the same functionality as the fixed key <b>SHIFT</b> .
Quick coding icon	Shows the quick coding configuration. Can be used with touch screen to turn quick coding on and off.
Softkeys	Commands can be executed using <b>F1-F6</b> keys. The commands assigned to the softkeys are screen dependent. Can be used directly with touch screen.
Scroll bar	Scrolls the screen area up and down.

---

## 2.4

## Operating Principles

### Keyboard and touch screen

The user interface is operated either by the keyboard or by the touch screen with supplied stylus. The workflow is the same for keyboard and touch screen entry, the only difference lies in the way information is selected and entered.

### Turn instrument on

Press and hold **PROG** for 2 s.

### Turn instrument off step-by-step

Step	Description
	The instrument can only be turned off in <b>TM6100A Main Menu</b> .
1.	Press and hold both <b>USER</b> and <b>PROG</b> simultaneously. OR Press <b>ESC</b> for more then 2 s.
2.	Press <b>YES (F6)</b> to continue or <b>NO (F4)</b> to cancel.

### Lock/Unlock keyboard

Option	Description
Lock	To lock the keyboard press and hold <b>SHIFT</b> for 3 s. The message 'Keyboard locked' is momentarily displayed on the Message Line.
Unlock	To unlock the keyboard press and hold <b>SHIFT</b> for 3 s. The message 'Keyboard unlocked' is momentarily displayed on the Message Line.

### Selecting from a menu

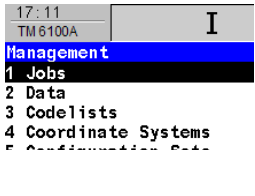
Appearance	Description
 <p>17:11 TM6100A I Management 1 Jobs 2 Data 3 Codelists 4 Coordinate Systems 5 Configuration Data</p>	<p>To select an item from a menu, do one of the following: Move the focus to the item. <b>ENTER</b> or <b>CONT (F1)</b>.</p> <p>OR</p> <p>Type the complete selection number in front of the item. <b>ENTER</b> or <b>CONT (F1)</b> are not required.</p> <p>OR</p> <p>Tap on the item with the stylus.</p>

### Selecting a page

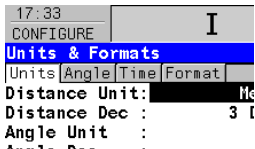
Appearance	Description
 <p>17:33 CONFIGURE I Units &amp; Formats Units   Angle   Time   Format Distance Unit: Me Distance Dec : 3 I Angle Unit : Angle Dec :</p>	<p>To select a page in a screen, do one of the following: <b>PAGE (F6)</b>.</p> <p>OR</p> <p>Tap on the page tab with the stylus.</p>

## Edit an entire value in input fields

Appearance	Description
	<ol style="list-style-type: none"><li>1. Highlight the field.</li><li>2. Type numeric and/or alphanumeric characters to overwrite.</li><li>3. <b>ENTER</b> or tap outside of the field.</li></ol>

## Edit an individual character in input fields

Appearance	Description
	<p>A character can be inserted or overwritten. The procedure is the same for both cases.</p> <ol style="list-style-type: none"><li>1. Highlight the field.</li><li>2. For the keyboard: <b>ENTER</b>. The edit mode is activated where additional functions like insert and overwrite are available.</li><li>3. For the touch screen: Highlight the characters to be changed.</li><li>4. Type numeric and/or alphanumeric characters.</li><li>5. <b>ENTER</b> or tap outside of the field.</li></ol>

### Access special alphanumeric characters for input

Step	Description
1.	Highlight the input field.
2.	For the keyboard: <b>ENTER</b> .
3.	Toggle to the desired special character set by using the up/down arrow keys.
4.	Press the function key assigned to the required character group.
5.	Press the function key with the required character.
6.	Repeat step 4. and 5. for entering more special characters of the same character set.
7.	<b>ENTER</b> .

### Appearance and selection from a choicelist

Chocelists have various appearances.

#### Closed choicelist

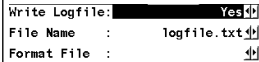
Appearance	Description	Selection
	Triangles on the right indicate further available choices.	Use the arrow keys ◀ ▶ to change through the list or tap the triangles on the screen.





**ENTER** or tap on the field to access the choicelist. Opening a choicelist reveals either a simple listbox or a comprehensive listbox dialog.

### Simple listbox

Appearance	Description	Selection
Date Format : Day.Month.Year Date : 06.03.06	<ul style="list-style-type: none"><li>• Choicelist shows items to select.</li><li>• A search field is shown if necessary.</li><li>• A scroll bar is shown if necessary.</li></ul>	<ul style="list-style-type: none"><li>• Highlight the item and <b>ENTER</b>.</li><li>• To exit without changes <b>ESC</b>, tap <input type="checkbox"/> or outside the simple listbox.</li></ul>

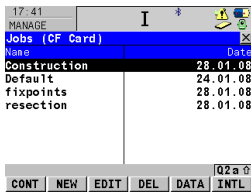
## Listbox dialog

Appearance	Description	Selection
 <p>17:41 MANAGE I * [Icons] Jobs (CF Card) [Close] Name Date Construction 28.01.08 Default 24.01.08 fixpoints 28.01.08 resection 28.01.08 [CONT] [NEW] [EDIT] [DEL] [DATA] [INTL]</p>	<ul style="list-style-type: none"> <li>• Choicelist fills the whole screen.</li> <li>• A search field is shown.</li> <li>• A scroll bar is shown if necessary.</li> <li>• The functionality comprise adding, editing and deleting of items.</li> <li>• Listbox dialogs are explained in detail at appropriate places in the manuals.</li> </ul>	<ul style="list-style-type: none"> <li>• Highlight the item and <b>CONT (F1)</b>.</li> <li>• To exit without changes press <b>ESC</b> or tap .</li> </ul>

## 2.5

## Icons

### Description

The screen icons display the current status information of the instrument.

### Position of the icons on the screen

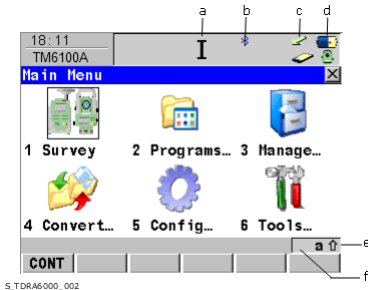

- a) Compensator/face I&II
- b) Bluetooth
- c) CompactFlash card/internal memory
- d) Battery
- e) **SHIFT**
- f) Quick coding

### Icons

Icon	Description
Reflector	The currently active reflector is displayed.
Compensator/face I&II	Compensator off, out of range or face I&II icon is displayed.

---

Icon	Description
<b>Bluetooth</b>	The status of each Bluetooth port and any Bluetooth connection is displayed.
<b>CompactFlash card/internal memory</b>	The status of the CompactFlash card and internal memory are displayed. <ul style="list-style-type: none"><li data-bbox="693 310 1359 370">• For the CompactFlash card, the capacity of used space is shown in seven levels.</li><li data-bbox="693 389 1359 449">• For the internal memory, the capacity of used memory is shown in nine levels.</li></ul>
<b>Battery</b>	The status and source of the battery is displayed. The percentage of remaining power capacity for all batteries are displayed numerically and graphically. For internal and external battery being attached at the same time the internal battery is used until it is empty and then the external battery is used.
<b>SHIFT</b>	The status of the <b>SHIFT</b> key is displayed.
<b>Quick coding</b>	Shows the quick coding configuration. Can be used with touch screen to turn quick coding on and off.

---

## 3

# Operation

### 3.1

## Instrument Setup

---

#### Description

This topic describes an instrument setup over a marked ground point using the laser plummet. It is always possible to set up the instrument without the need for a marked ground point.

---



Important features:

- It is always recommended to shield the instrument from direct sunlight and avoid uneven temperatures around the instrument.
  - The laser plummet described in this topic is built into the vertical axis of the instrument. It projects a red spot onto the ground, making it appreciably easier to centre the instrument.
  - The laser plummet cannot be used in conjunction with a tribrach equipped with an optical plummet.
-

## Setup step-by-step

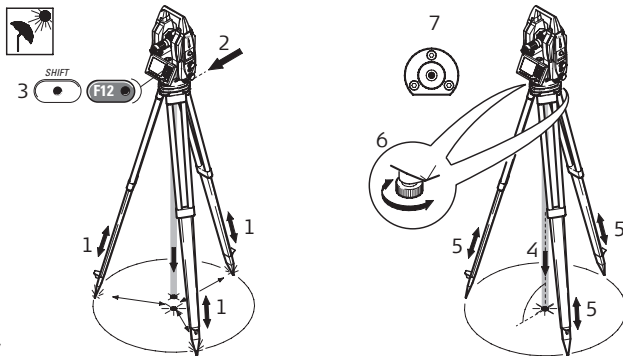

TM6100A.007

Step	Description
	Shield the instrument from direct sunlight and avoid uneven temperatures around the instrument.
1.	Extend the tripod legs to allow for a comfortable working posture. Position the tripod over the marked ground point, centring it as well as possible.
2.	Fasten the tribrach and instrument onto the tripod.

Step	Description
3.	Turn on the instrument by pressing <b>PROG</b> for 2 s. Press <b>SHIFT (F12)</b> to access <b>STATUS Level &amp; Laser Plummet</b> , activating the laser plummet.
4.	Move the tripod legs (1) and use the tribrach footscrews (6) to centre the plummet (4) over the ground point.
5.	Adjust the tripod legs to level the circular level (7).
6.	By using the electronic level turn the tribrach footscrews (6) to precisely level the instrument.
7.	Centre the instrument precisely over the ground point (4) by shifting the tribrach on the tripod plate (2).
8.	Repeat steps 6. and 7. until the required accuracy is achieved.

## 3.2

## Battery

### 3.2.1

### Operating Principles

---



#### Primary use/charging

- The battery must be charged prior to using it for the first time because it is delivered with an energy content as low as possible.
- For new batteries or batteries that have been stored for a long time (> three months), it is effectual to make only one charge/discharge cycle.
- For Li-Ion batteries, a single discharging and charging cycle is sufficient. We recommend carrying out the process when the battery capacity indicated on the charger or on a Leica Geosystems product deviates significantly from the actual battery capacity available.
- The permissible temperature range for charging is between 0°C to +40°C/+32°F to +104°F. For optimal charging we recommend charging the batteries at a low ambient temperature of +10°C to +20°C/+50°F to +68°F if possible.
- It is normal for the battery to become warm during charging. Using the chargers recommended by Leica Geosystems, it is not possible to charge the battery if the temperature is too high.

#### Operation/Discharging

- The batteries can be operated from -20°C to +55°C/-4°F to +131°F.
  - Low operating temperatures reduce the capacity that can be drawn; very high operating temperatures reduce the service life of the battery.
-



## 3.2.2

## Instrument Battery

### Change battery step-by-step

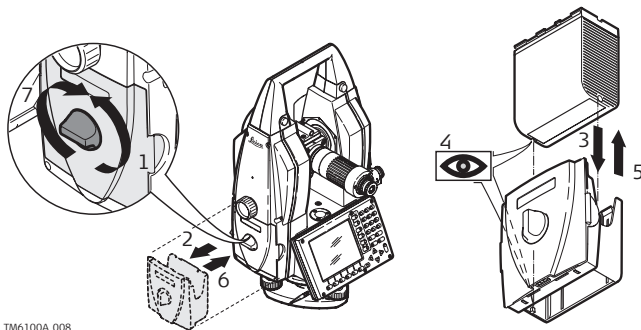

TM6100A\_008

Step	Description
1.	Face the instrument on the side with the single finnedrive. The battery compartment is located just below. Turn the knob to the vertical position, opening the lid of the battery compartment.
2.	Pull out the battery housing.
3.	Pull the battery from the battery housing.

---

Step	Description
4.	A pictogram of the battery is displayed inside the battery housing. This is a visual aid to assist in placing the battery correctly.
5.	Place the battery into the battery housing, ensuring that the contacts are facing outward. Click the battery into position.
6.	Place the battery housing into the battery compartment. Push the battery housing in until it fits completely into the battery compartment.
7.	Turn the knob to lock the battery compartment. Ensure that the knob is returned to its original horizontal position.

---

### 3.3

## Working with the CompactFlash Card



- Keep the card dry.
- Use it only within the specified temperature range.
- Do not bend the card.
- Protect the card from direct impacts.



Failure to follow these instructions could result in data loss and/or permanent damage to the card.

### Insert and remove a CompactFlash card step-by-step

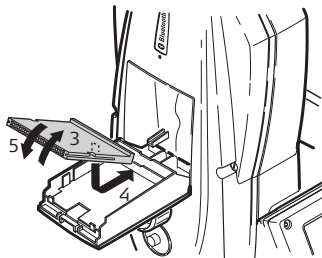
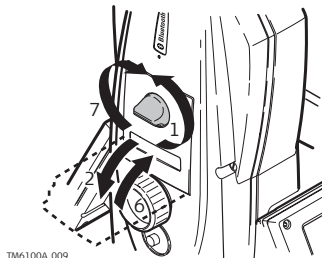



---

Step	Description
1.	Face the instrument so that the CompactFlash card compartment is on the right side of the instrument. Turn the knob to the vertical position, opening the lid of the CompactFlash card compartment.
2.	Open the lid of the CompactFlash card compartment.
3.	Pull the front of the CompactFlash card up and take the card out of the lid.
4.	Place the lower end of the CompactFlash card at the lower end of the CompactFlash card compartment. The extended edge of the card has to be on the upper side as shown on the pictogram in the CompactFlash card compartment.
5.	Press the card down on the lid.
6.	Close the lid.
7.	Turn the knob to lock the CompactFlash card compartment. The lid is closed correctly when the knob is turned to a horizontal position.

---

## Format a CompactFlash card step-by-step

Formatting the CompactFlash card before starting to store data is required if a completely new CompactFlash card is used or if all existing data needs to be deleted.

Step	Description
1.	<b>Main Menu: Tools...\Format Memory Device.</b>
2.	<b>TOOLS Format Memory Device</b> <b>&lt;Memory Device: CF Card&gt;</b> <b>&lt;Format Method: Format Quick&gt;</b> Select the memory device to be formatted.
	By activating the format command all data will be lost. Make sure that all important data on the CompactFlash card has been backed up before formatting the card. Before formatting the internal memory make sure that all important data is first transferred to the PC.
	To exit the screen without formatting the memory device, press <b>ESC</b> . This returns to the previous screen without execution of any command.
3.	<b>CONT (F1).</b>
4.	<b>YES (F4)</b> to complete the formatting of the CompactFlash card.
	<b>NO (F6)</b> to abort the formatting of the CompactFlash card and return to <b>TOOLS Format Memory Device.</b>
5.	Once the formatting of the CompactFlash card is completed the system returns to <b>TM6100A Main Menu.</b>

## 3.4 Accessing Survey Application Program

### Access







Select **Main Menu: Survey**.

OR

Press **PROG**. Highlight Survey. **CONT (F1)**.

### SURVEY

#### Survey Begin

18:13	I		
SURVEY			
<b>Survey Begin</b>			
Job	:	Default	
Config Set	:	TM6100A Cable	

#### CONT (F1)

To accept changes and access the subsequent screen. The chosen settings become active.

#### CONF (F2)

To access **SURVEY Configuration**.

#### SETUP (F3)

Opens **SETUP Station Setup** to set station and orientation.

#### CSYS (F6)

To select a different coordinate system. Not available for **<Use Auto CrdSys: Yes>** configured in **CONFIGURE Additional Rover Settings**.

				a ↑
CONT	CONF	SETUP		CSYS

## Description of fields

Field	Option	Description
<Job:>	Choicelist	The active job. All jobs from <b>Main Menu: Manage...\Jobs</b> can be selected.
<Coord System:>	Output	The coordinate system currently attached to the selected <Job:>. Cannot be edited for <Use AutoCrdSys: Yes> configured in <b>CONFIGURE Additional Rover Settings</b> .
<Codelist:>	Choicelist  Output	No codes are stored in the selected <Job:>. All codelists from <b>Main Menu: Manage...\Codelists</b> can be selected.  Codes have already been stored in the selected <Job:>. If codes had been copied from a System RAM codelist, then the name of the codelist is displayed. If codes have not been copied from a System RAM codelist but typed in manually, then the name of the active job is displayed.
<Config Set:>	Choicelist	The active configuration set. All configuration sets from <b>Main Menu: Manage...\Configuration Sets</b> can be selected.

---

Field	Option	Description
		The instrument has numerous user configuration parameters and functions. This allows a variety of preferences to be addressed. The configuration of the parameters and functions for an individual measuring technique are combined in a configuration set.
<Reflector:>	Choicelist	Displays the active reflector. All reflectors from <b>Main Menu: Manage...\Reflectors</b> . All listed reflectors can be selected.
<Add. Constant:>	Output	Displays the additive constant stored with the chosen reflector.

**Next step**

**CONT (F1)** to access **SURVEY Survey: Job Name**, where measurements can be performed with **ALL (F1)** or **DIST (F2)** and/or **REC (F3)**.

---



## 3.5 Built-in autocollimation device

### AL51 plug-in lamp

The TM6100A is equipped with a built-in autocollimation device. To illuminate the autocollimation reticule and project it to an autocollimation mirror, plug the AL51 plug-in lamp into the socket on the telescope.

### Illumination

To switch the illumination on or off select **SHIFT (F11)** to access **CONFIGURE Lights Display, Beeps, Text**. Highlight the line **Autocollim**, toggle On or Off and press to **CONT (F1)** to continue.

The brightness of the autocollimation lamp may be adjusted by turning the knob on the autocollimation lamp.

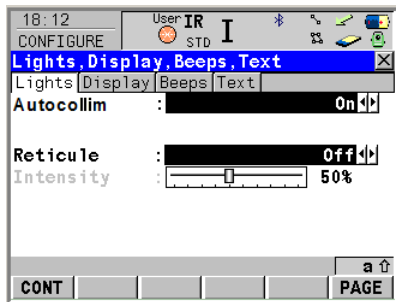

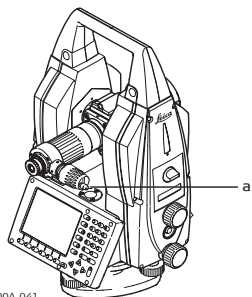

TM6100A\_041

a) Intensity actuator

## 3.6

### Connection to Application Computer

---

#### Connection types

There are three basic connection types to connect a TM6100A to an application computer:

- Cable connection via T-LINK
  - Cable connection via USB Download Cable GEV218 or Y-Cable GEV220
  - Wireless Bluetooth connection
-

**T-LINK**

The connection via T-LINK connects up to 8 TM6100A to an application computer. The connection requires the following components:

- T-LINK
- Data Cable GEV86-I (20 m)
- Data transfer cable to RS232 port of the application computer.

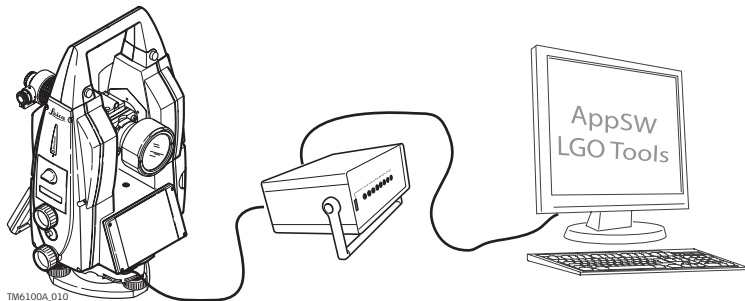

TM6100A\_010



It is not recommended to upload any firmware or software via the T-LINK and the 20 m data cable. Use the short data cable or the USB Download Cable GEV218.

## Direct cable connection

The direct cable connection connects a single instrument to an application computer. The connection requires the following components:

- USB Download Cable GEV218 or Y-Cable GEV220

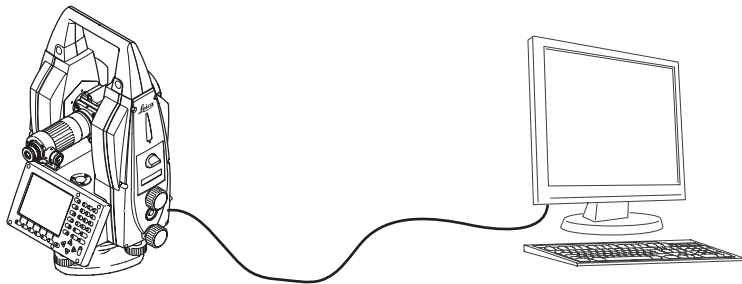

TM6100A\_011

**Bluetooth connection**

A Bluetooth connection to an application computer can be established through the internal bluetooth modul. The connection requires the following setup:

- Paired bluetooth communication between TM6100A and application computer.

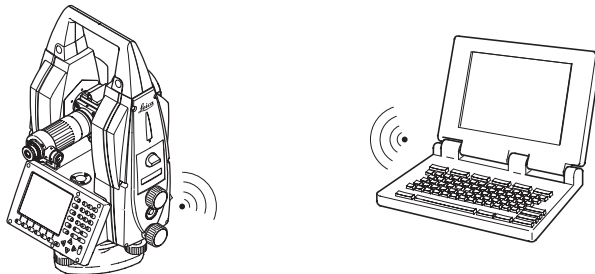

TM6100A\_012

## 3.7

# Limitation of the horizontal and vertical movements

---

### General

Due to the size of the panfocal telescope of the TM6100A a face change can only be done through the lens side. This requires a turning restriction for the vertical movement of the telescope.

In addition the motorized horizontal movements can be restricted because of accessories attached, i.e. Diode Laser DL2/3.

If a turning restriction is defined, the TM6100A will not pass or enter a certain vertical or horizontal sector.

---

### Vertical Limitations

The default limits for vertical movements are applied as shown below.

---

Telescope side	Range	Value
Eyepiece	V Begin	55 gon
	V End	344 gon
Lens	V Begin	n/a
	V End	n/a
Use Limit		Eyepiece

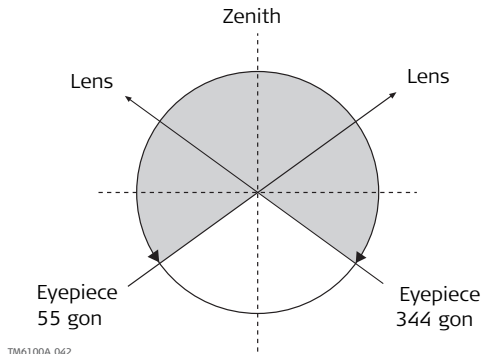
**Free turning range for eyepiece:****Custom limitations**

In case of additional accessories used on the telescope, Individual limitations can be applied to the horizontal and vertical movements.

**Access**

Select **Main Menu: Config...\Instrument Settings...\Telescope Accessories.**



## CONFIGURE, Telescope Accessories, Hz Limits



### CONT (F1)

To accept changes and return to the **TM6100A Main Menu**.

### NEW (F2)

To define new horizontal limits for motorized rotation.

### SHOW (F5)

To position the telescope to its rotation limits.

### PAGE (F6)

To change to another page on this screen.

---

### Description of fields:

Field	Option	Description
<Hz Begin:> <Hz End:>	Output/user Input	The boundaries of the window within the instrument is allowed to turn.
<Use Limit:>	Yes	Motorized instrument turning is restricted to the defined window.

Field	Option	Description
	No	Instruments turns without any limitation.

**Next step**

**PAGE (F6)** to change to the **V Limit** page.

**CONFIGURE, Tele-  
scope Accessories,  
V Limits**

**CONT (F1)**

To accept changes and return to the **TM6100A Main Menu**.

**NEW (F2)**

To define new horizontal limits for motorized rotation.

**SHOW (F5)**

To position the telescope to its rotation limits.

**PAGE (F6)**

To change to another page on this screen.

### Description of fields:

Field	Option	Description
<V Begin:> <V End:>	Output/user Input	Vertical extent of the window in which the instrument is allowed to turn the telescope.
<Use Limit:>	<b>None</b>	Instruments turns without any limitation.
	<b>Eyepiece</b>	 Do not use with <b>TM6100A</b> . The movement of the telescope is limited by the stored Eyepiece Accessories limits.
	<b>Lens</b>	The movement of the telescope is limited by the stored Lens Accessories limits.
	<b>Eyepiece &amp; Lens</b>	The movement of the telescope is limited by the combination of both areas with the least vertical extent.

## 4 Check & Adjust

### 4.1 Overview

---

#### Description

Leica instruments are manufactured, assembled and adjusted to the best possible quality. Quick temperature changes, shock or stress can cause deviations and decrease the instrument accuracy.

It is therefore recommended to check and adjust the instrument from time to time. This can be done in the field by running through specific measurement procedures. The procedures are guided and have to be followed carefully and precisely as described in the following chapters. Some other instrument errors and mechanical parts can be adjusted mechanically.

---

#### Electronic adjustment

The following instrument errors can be checked and adjusted electronically:

l, t	Compensator longitudinal and transversal index errors
i	Vertical index error, related to the standing axis
c	Hz collimation error, also called line of sight error
a	Tilting axis error

Every angle measured in the daily work is corrected automatically if the compensator and the Hz-corrections are activated in the instrument configuration. Select **Main Menu: Config...\Instrument Settings...\Compensator** to check the settings.

---

## View current adjustment errors

The currently used adjustment errors can be viewed under **Main Menu: Tools.../Check & Adjust...\Current Values.**

---

## Mechanical adjustment

The following instrument parts can be adjusted mechanically:

- Circular level on instrument and tribrach
  - Laser plummet
  - Optical plummet - option on tribrach
  - Allen screws on tripod
- 

## Precise measurements

To get precise measurements in the daily work, it is important:

- To check and adjust the instrument from time to time.
  - To take high precision measurements during the check and adjust procedures.
  - To measure targets in two faces. Some of the instrument errors are eliminated by averaging the angles from both faces.
  - Refer to "4.2 Preparation" to find more important points.
- 



During the manufacturing process, the instrument errors are carefully determined and set to zero. As mentioned above, these errors can change and it is highly recommended to redetermine them in the following situations:

- Before the first use
- Before every high precision survey
- After rough or long transportations
- After long working periods

- After long storage periods
- If the temperature difference between current environment and the temperature at the last calibration is more than 20°C

**Summary of errors to be adjusted electronically**

<b>Instrument error</b>	<b>Effects Hz</b>	<b>Effects V</b>	<b>Elimination with two face measurement</b>	<b>Automatically corrected with proper adjustment</b>
c - Line of sight error	✓	---	✓	✓
a - Tilting axis error	✓	---	✓	✓
l - Compensator index error	---	✓	✓	✓
t - Compensator index error	✓	---	✓	✓
i - V-Index error	---	✓	✓	✓

## 4.2

### Preparation

---



Before determining the instrument errors, the instrument has to be levelled up using the electronic level. **SHIFT F12** to access **STATUS Level & Laser Plummet, Level** page.

The tribrach, the tripod and the underground should be very stable and secure from vibrations or other disturbances.

---



The instrument should be protected from direct sunlight in order to avoid thermal warming.

It is also recommended to avoid strong heat shimmer and air turbulence. The best conditions are usually early in the morning or with overcast sky.

---



Before starting to work, the instrument has to become acclimatised to the ambient temperature. Approximately two minutes per °C of temperature difference from storage to working environment but at least 15 min should be taken into account.

---



Take the carry handle off the TM6100A when calibrating and measuring as the telescope may not turn to the second face with the carry handle mounted. Generally calibration and measurement set up should be carried out with the same instrument configuration.

---

## Next step

IF the task is to	THEN
adjust a combination of instrument errors	Refer to "4.3 Combined Adjustment (l, t, i and c)"
adjust the tilting axis	Refer to "4.4 Tilting Axis Adjustment (a)"
adjust the circular level	Refer to "4.5 Adjusting the Circular Level of the Instrument and Tribrach"
adjust the laser/optical plummet	Refer to "4.7 Inspecting the Laser Plummet of the Instrument"
adjust the tripod	Refer to "4.8 Servicing the Tripod"



## 4.3

## Combined Adjustment (l, t, i and c)

### Description

The combined adjustment procedure determines the following instrument errors in one process:



l, t	Compensator longitudinal and transversal index errors
i	Vertical index error, related to the standing axis
c	Hz collimation error, also called line of sight error

### Combined adjustment procedure step-by-step

The following table explains the most common settings.

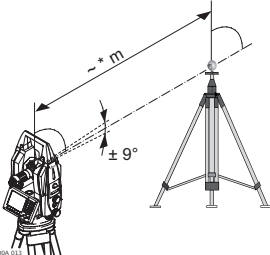
Step	Description
1.	<b>Main Menu: Tools...\Check &amp; Adjust...</b>
2.	<b>TOOLS Check &amp; Adjust Menu</b>
	Select the option: <b>Combined (l,t,i,c,ATR)</b>
3.	<b>TOOLS Combined I</b>

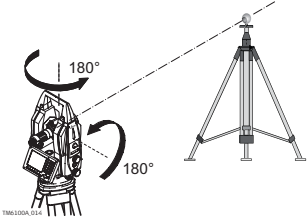
Step	Description
4.	 <p>Aim the telescope accurately at a target at about the usual working distance. The target must be positioned within <math>\pm 9^\circ/\pm 10</math> gon of the horizontal plane. The procedure can be started in any telescope face.</p> <p>*: Typical working distance, minimum 15 meter.</p>

Step	Description
5.	<p><b>MEAS (F1)</b> to measure and to continue to the next screen.</p>  <p>TM6100A_014</p> <p>TM6100A are motorised instruments and change automatically to the other face.</p> <p> The fine pointing has to be performed manually in both faces.</p>
6.	<p><b>TOOLS Combined II</b></p>
	<p><b>MEAS (F1)</b> to measure the same target in the other face and to calculate the instrument errors.</p>
	<p>If one or more errors are bigger than the predefined limits, the procedure has to be repeated. All measurements of the current run are rejected and none of them is averaged with the results from previous runs.</p>
7.	<p><b>TOOLS Adjustment Accuracy</b></p>

Step	Description
	<p><b>&lt;No.of Meas:&gt;</b> Shows the number of runs executed. One run consists of a measurement in face I and face II.</p> <p><b>&lt;<math>\sigma</math> I Comp:&gt;</b> and similar lines show the standard deviations of the determined adjustment errors. The standard deviations can be calculated from the second run onwards.</p>
	It is recommended to measure at least two runs.
8.	<p><b>MEAS (F5)</b> if more runs have to be added. Continue with step 3.</p> <p>OR</p> <p><b>CONT (F1)</b> to accept the measurements and to proceed to <b>TOOLS Adjustment Results</b>. No more runs can be added later.</p>

## Next step

IF the results are	THEN
to be stored	<b>CONT (F1)</b> overwrites the old adjustment errors with the new ones, if the <b>Use</b> status is set to <b>Yes</b> .
to be determined again	<b>REDO (F2)</b> rejects all new determined adjustment errors and repeats the whole procedure. Refer to step 3. of paragraph "Combined adjustment procedure step-by-step".

## 4.4

## Tilting Axis Adjustment (a)

### Description

This adjustment procedure determines the following instrument error:  
a Tilting axis error



### Determination of tilting axis error step-by-step

The following table explains the most common settings.

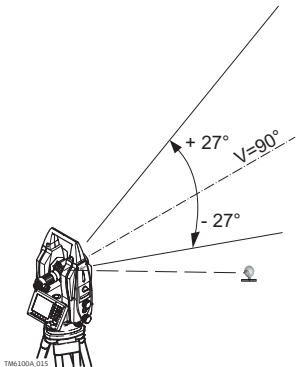
Step	Description
	The Hz collimation error (c) has to be determined before starting this procedure.
1.	<b>Main Menu: Tools...\Check &amp; Adjust...</b>
2.	<b>TOOLS Check &amp; Adjust Menu</b> Select the option: <b>Tilting Axis (a)</b>

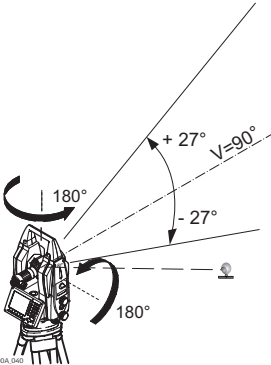
Step	Description
3.	<p data-bbox="474 163 899 192"><b>TOOLS Tilting-Axis Adjustment I</b></p> <p data-bbox="876 197 1365 356">Aim the telescope accurately at a target at about the usual working distance. The target must be positioned at least <math>27^{\circ}/30</math> gon above or beneath the horizontal plane.</p> <p data-bbox="876 363 1365 422">The procedure can be started in any telescope face.</p>  <p>The diagram shows a surveying telescope mounted on a tripod. A horizontal dashed line extends from the telescope's center to a small target symbol on the right. Two solid lines represent the telescope's field of view, one angled upwards and one downwards. A dashed line is drawn perpendicular to the horizontal line, labeled <math>V=90^{\circ}</math>. An arc between the horizontal line and the upper solid line is labeled <math>+27^{\circ}</math>. An arc between the horizontal line and the lower solid line is labeled <math>-27^{\circ}</math>. The telescope is labeled with the code TM6100A.015 at the bottom left.</p>

Step	Description
4.	<p><b>MEAS (F1)</b> to measure and to continue to the next screen.</p> <p>TM6100A are motorised instruments and change automatically to the other face.</p> <p> The fine pointing has to be performed manually in both faces.</p>  <p>TM6100A_0402</p>
5.	<p><b>TOOLS Tilting-Axis Adjustment II</b></p> <p><b>MEAS (F1)</b> to measure the same target in the other face and to calculate the tilting axis error.</p>

Step	Description
	If the error is bigger than the predefined limit, the procedure has to be repeated. The tilting axis measurements of the current run are then rejected and not averaged with the results from previous runs.
6.	<b>TOOLS T-Axis Adjustment Accuracy</b> <b>&lt;No.of Meas:&gt;</b> Shows the number of runs executed. One run consists of a measurement in face I and face II. <b>&lt;<math>\sigma</math> a T-axis:&gt;</b> shows the standard deviation of the determined tilting axis error. The standard deviation can be calculated from the second run onwards.
	It is recommended to measure at least two runs.
7.	<b>MEAS (F5)</b> if more runs have to be added. Continue with step 3. OR <b>CONT (F1)</b> to accept the measurements and to proceed to <b>TOOLS T-Axis Adjustment Result</b> . No more runs can be added later.



## Next step

IF the results are	THEN
to be stored	<b>CONT (F1)</b> overwrites the old tilting axis error with the new one.
to be determined again	<b>REDO (F2)</b> rejects the new determined tilting axis error and repeats the whole procedure. Refer to step 3. of paragraph "Determination of tilting axis error step-by-step".

---

## 4.5 Adjusting the Circular Level of the Instrument and Tribrach

### Adjusting the circular level step-by-step

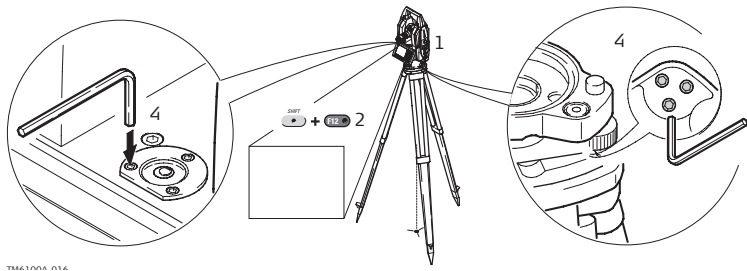

TM6100A 014



Step	Description
1.	Place and secure the instrument into the tribrach and onto a tripod.
2.	Using the tribrach footscrews, level the instrument with the electronic level. <b>SHIFT (F12)</b> to access <b>STATUS Level &amp; Laser Plummet</b> .
3.	Check the position of the circular level on the instrument and tribrach.
4.	a) If both circular levels are centered, no adjustments are necessary
	b) If one or both circular levels are not centered, adjust as follows:

Step	Description
	<b>Instrument:</b> If it extends beyond the circle, use the supplied allen key to centre it with the adjustment screws. Turn the instrument by 200 gon (180°). Repeat the adjustment procedure if the circular level does not stay centered.
	<b>Tribrach:</b> If it extends beyond the circle, use the supplied allen key to centre it with the adjustment screws.
	After the adjustments, all adjusting screws should have the same tightening tension and no adjusting screw shall be loose.

## 4.6

## Adjusting the Circular Level of the Prism Pole

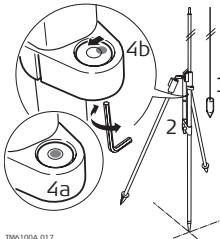
## Adjusting the circular level step-by-step

Step	Description	
1.	Suspend a plumb line.	 <p>TM6100A.017</p>
2.	Using a pole bipod, align the prism pole parallel to the plumb line.	
3.	Check the position of the circular level on the prism pole.	
4.	a) If the circular level is centered, no adjustment is necessary.	
	b) If the circular level is not centered, use an allen key to centre it with the adjustment screws.	
	After the adjustments, all adjusting screws should have the same tightening tension and no adjusting screw shall be loose.	

## 4.7

# Inspecting the Laser Plummet of the Instrument



The laser plummet is located in the vertical axis of the instrument. Under normal conditions of use, the laser plummet does not need adjusting. If an adjustment is necessary due to external influences, the instrument has to be returned to any Leica Geosystems authorized service workshop.

### Inspecting the laser plummet step-by-step

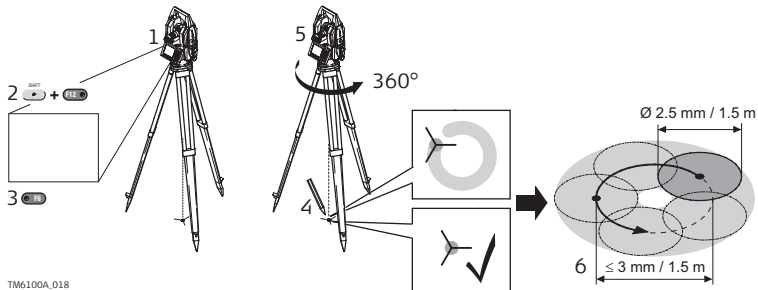

TM6100A\_018

The following table explains the most common settings.

Step	Description
1.	Place and secure the instrument into the tribrach and onto a tripod.
2.	Using the tribrach footscrews, level the instrument with the electronic level. <b>SHIFT (F12)</b> to access <b>STATUS Level &amp; Laser Plummet</b> .
3.	<b>PAGE (F6)</b> to access the <b>Laser Plummet</b> page. Switch on the laser plummet. Inspection of the laser plummet should be carried out on a bright, smooth and horizontal surface, like a sheet of paper.
4.	Mark the centre of the red dot on the ground.
5.	Turn the instrument through 360° slowly, carefully observing the movement of the red laser dot.
	The maximum diameter of the circular movement described by the centre of the laser point should not exceed 3 mm at a distance of 1.5 m.
6.	If the centre of the laser dot describes a perceptible circular movement or moves more than 3 mm away from the point which was first marked, an adjustment may be required. Inform your nearest Leica Geosystems authorized service workshop. Depending on brightness and surface, the diameter of the laser dot can vary. At 1.5 m it is about 2.5 mm.

## 4.8

## Servicing the Tripod

### Servicing the tripod step-by-step

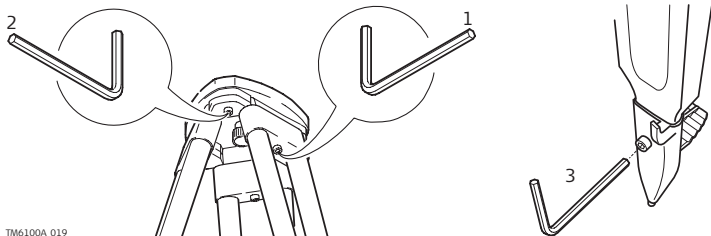

TM6100A\_019

The following table explains the most common settings.

Step	Description
	The connections between metal and timber components must always be firm and tight.
1.	Tighten the leg cap screws moderately, with the supplied allen key.
2.	Tighten the articulated joints on the tripod head just enough to keep the tripod legs open when lifting the tripod off the ground.
3.	Tighten the allen screws of the tripod legs.

---

## 4.9 Adjustment of the autocollimation reticule

---

### Description

The built-in autocollimation device has an additional "negative" reticule, which is projected through the telescope and observed by the linear cross of the standard reticule.

To achieve accurate results the negative reticule must coincide to the standard reticule.

---

### Check

Set up an autocollimation mirror about 5 m (16 ft) from the instrument. Adjust the reflecting surface perpendicular to the telescope's line of sight.

Adjust the telescope to focus on the image of the negative linear cross reflected by the mirror, i.e. focus to double the distance between telescope and mirror. Do not focus to infinity. The standard black reticule and the negative green linear cross should be aligned and centered. When moving the telescope over the mirror both reticules stay aligned.

---

### Adjustment

If the two crosshairs do not coincide. adjust by means of the four setting screws (1 to 4). Screws 1 and 2 move the negative reticule sideways, screws 3 and 4 move it up and down.

These screws are paired and act reciprocal. When loosening one of a pair, immediately tighten the other one by the same amount. Do not over tighten!

To access screw 4 remove the metal cover plate by unscrewing the slotted screw.

---



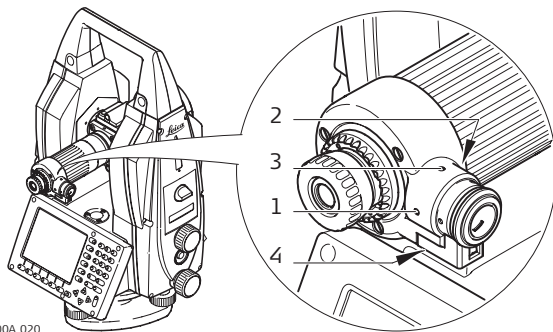

TM6100A\_020

## 5 Care and Transport

### 5.1 Transport

#### Telescope protection cushion

To protect the telescope from damage, a protection cushion holds the telescope in a particular position when the instrument is stored in the transport container. Position the telescope and attach the protection cushion according to the picture located on the bottom of the transport container.

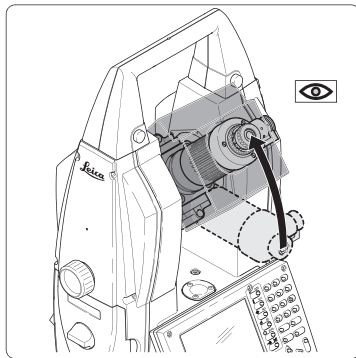

**Transport in the field**

When transporting the equipment in the field, always make sure that you

- either carry the product in its original transport container,
  - or carry the tripod with its legs splayed across your shoulder, keeping the attached product upright.
- 

**Transport in a road vehicle**

Never carry the product loose in a road vehicle, as it can be affected by shock and vibration. Always carry the product in its transport container and secure it.

---

**Shipping**

When transporting the product by rail, air or sea, always use the complete original Leica Geosystems packaging, transport container and cardboard box, or its equivalent, to protect against shock and vibration.

---

**Shipping, transport of batteries**

When transporting or shipping batteries, the person in charge of the product must ensure that the applicable national and international rules and regulations are observed. Before transportation or shipping, contact your local passenger or freight transport company.

---

**Field adjustment**

After transport inspect the field adjustment parameters given in this user manual before using the product.

---

---

<b>5.2</b>	<b>Storage</b>
<b>Product</b>	Respect the temperature limits when storing the equipment, particularly in summer if the equipment is inside a vehicle. Refer to "7 Technical Data" for information about temperature limits.
<b>Field adjustment</b>	After long periods of storage inspect the field adjustment parameters given in this user manual before using the product.
<b>Li-Ion batteries</b>	<ul style="list-style-type: none"><li>• Refer to "7.3 General Technical Data of the Instrument" for information about storage temperature range.</li><li>• A storage temperature range of -20°C to +30°C/-4°F to +86°F in a dry environment is recommended to minimize self-discharging of the battery.</li><li>• At the recommended storage temperature range, batteries containing a 10% to 50% charge can be stored for up to one year. After this storage period the batteries must be recharged.</li><li>• Remove batteries from the product and the charger before storing.</li><li>• After storage recharge batteries before using.</li><li>• Protect batteries from damp and wetness. Wet or damp batteries must be dried before storing or use.</li></ul>

---

## 5.3

## Cleaning and Drying

---

### Product and accessories

- Blow dust off lenses and prisms.
  - Never touch the glass with your fingers.
  - Use only a clean, soft, lint-free cloth for cleaning. If necessary, moisten the cloth with water or pure alcohol. Do not use other liquids; these may attack the polymer components.
- 

### Fogging of prisms

Reflector prisms that are cooler than the ambient temperature tend to fog. It is not enough simply to wipe them. Keep them for some time inside your jacket or in the vehicle to allow them to adjust to the ambient temperature.

---

### Damp products

Dry the product, the transport container, the foam inserts and the accessories at a temperature not greater than 40°C / 104°F and clean them. Do not repack until everything is completely dry. Always close the transport container when using in the field.

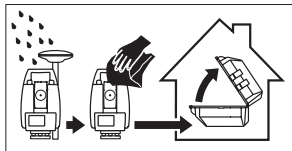

**Cables and plugs**

Keep plugs clean and dry. Blow away any dirt lodged in the plugs of the connecting cables.

---

## 5.4



## Maintenance

---

An inspection of the product must be done in a Leica Geosystems authorized service workshop. Leica Geosystems recommends an inspection of the product every 24 months.

As TM6100A instruments are equipped with a self-surveillance system designed for maximum motor performance and long maintenance cycles Leica Geosystems recommends inspection of the product whenever indicated in the message line of the user interface.

---

---

## 6 Safety Directions

### 6.1 General Introduction

---

**Description**

The following directions should enable the person responsible for the product, and the person who actually uses the equipment, to anticipate and avoid operational hazards.

The person responsible for the product must ensure that all users understand these directions and adhere to them.

---



## 6.2

## Intended Use

---

### Permitted use

- Measuring horizontal and vertical angles.
  - Recording measurements.
  - Visualizing the aiming direction and vertical axis.
  - Remote control of product.
  - Data communication with external appliances.
  - Transmission of measurement data to an external application PC.
  - Transmission of coordinates from an external application PC to the product for inspection and build measurements.
  - Computing by means of software.
- 

### Adverse use

- Use of the product without instruction.
- Use outside of the intended limits.
- Disabling safety systems.
- Removal of hazard notices.
- Opening the product using tools, for example screwdriver, unless this is specifically permitted for certain functions.
- Modification or conversion of the product.
- Use after misappropriation.
- Use of products with obviously recognizable damages or defects.

- 
- Use with accessories from other manufacturers without the prior explicit approval of Leica Geosystems.
  - Aiming directly into the sun.
  - Inadequate safeguards at the working site, for example when measuring on roads.
  - Deliberate dazzling of third parties.
  - Controlling of machines, moving objects or similar monitoring application without additional control- and safety installations.

 **Warning**

Adverse use can lead to injury, malfunction and damage.

It is the task of the person responsible for the equipment to inform the user about hazards and how to counteract them. The product is not to be operated until the user has been instructed on how to work with it.

---

## 6.3

### Limits of Use

---

#### Environment

Suitable for use in an atmosphere appropriate for permanent human habitation: not suitable for use in aggressive or explosive environments.



#### Danger

Local safety authorities and safety experts must be contacted before working in hazardous areas, or in close proximity to electrical installations or similar situations by the person in charge of the product.

---

## 6.4 Responsibilities

---

### Manufacturer of the product

Leica Geosystems AG, CH-9435 Heerbrugg, hereinafter referred to as Leica Geosystems, is responsible for supplying the product, including the user manual and original accessories, in a completely safe condition.

---

### Manufacturers of non Leica Geosystems accessories

The manufacturers of non Leica Geosystems accessories for the product are responsible for developing, implementing and communicating safety concepts for their products, and are also responsible for the effectiveness of those safety concepts in combination with the Leica Geosystems product.

---

### Person in charge of the product

The person in charge of the product has the following duties:

- To understand the safety instructions on the product and the instructions in the user manual.
- To be familiar with local regulations relating to safety and accident prevention.
- To inform Leica Geosystems immediately if the product and the application becomes unsafe.
- To ensure that the national laws, regulations and conditions for the operation of radio transmitters are respected.



### Warning

The person responsible for the product must ensure that it is used in accordance with the instructions. This person is also accountable for the training and the deployment of personnel who use the product and for the safety of the equipment in use.

---

## 6.5

## Hazards of Use

---

### Warning

The absence of instruction, or the inadequate imparting of instruction, can lead to incorrect or adverse use, and can give rise to accidents with far-reaching human, material, financial and environmental consequences.

#### **Precautions:**

All users must follow the safety directions given by the manufacturer and the directions of the person responsible for the product.

---

### Caution

Watch out for erroneous measurement results if the product has been dropped or has been misused, modified, stored for long periods or transported.

#### **Precautions:**

Periodically carry out test measurements and perform the field adjustments indicated in the user manual, particularly after the product has been subjected to abnormal use and before and after important measurements.

---

### Caution

Reflectors can cause personal injury and/or mechanical damage, when dropped.

#### **Precautions:**

Secure the reflector with a lanyard when moving the reflector.

---

 **Warning**

Mounting the sensor on unstable or uneven ground may cause the sensor to tip over or cause unreliable measurement results.

**Precautions:**

Ensure the ground is stable and even. Do not place the sensor over cracks in the floor.

---

 **Danger**

Because of the risk of electrocution, it is very dangerous to use poles and extensions in the vicinity of electrical installations such as power cables or electrical railways.

**Precautions:**

Keep at a safe distance from electrical installations. If it is essential to work in this environment, first contact the safety authorities responsible for the electrical installations and follow their instructions.

 **Caution**

With the remote control of products, it is possible that extraneous targets will be picked out and measured.

**Precautions:**

When measuring in remote control mode, always check your results for plausibility.

---

 **Warning**

If the product is used with accessories, for example masts, staffs, poles, you may increase the risk of being struck by lightning.

**Precautions:**

Do not use the product in a thunderstorm.

---

 **Caution**

Be careful when pointing the product towards the sun, because the telescope functions as a magnifying glass and can injure your eyes and/or cause damage inside the product.

**Precautions:**

Do not point the product directly at the sun.

---

 **Warning**

During dynamic applications, for example stakeout procedures there is a danger of accidents occurring if the user does not pay attention to the environmental conditions around, for example obstacles, excavations or traffic.

**Precautions:**

The person responsible for the product must make all users fully aware of the existing dangers.

---





 **Warning**

Inadequate securing of the measurement site can lead to dangerous situations, especially at industrial installations.

**Precautions:**

Always ensure that the measurement site is adequately secured. Adhere to the regulations governing safety and accident prevention and road traffic.

---

- 
-  **Warning** Only Leica Geosystems authorized service workshops are entitled to repair these products.
- 
-  **Warning** If computers intended for use indoors are used in the field there is a danger of electric shock.  
**Precautions:**  
Adhere to the instructions given by the computer manufacturer with regard to field use in conjunction with Leica Geosystems products.
- 
-  **Caution** If the accessories used with the product are not properly secured and the product is subjected to mechanical shock, for example blows or falling, the product may be damaged or people may sustain injury.  
**Precautions:**  
When setting-up the product, make sure that the accessories are correctly adapted, fitted, secured, and locked in position.  
Avoid subjecting the product to mechanical stress.
- 
-  **Caution** During the transport, shipping or disposal of batteries it is possible for inappropriate mechanical influences to constitute a fire hazard.  
**Precautions:**  
Before shipping the product or disposing of it, discharge the batteries by running the product until they are flat.  
When transporting or shipping batteries, the person in charge of the product must ensure that the applicable national and international rules and regulations are



observed. Before transportation or shipping contact your local passenger or freight transport company.

---

 **Warning**

Using a battery charger not recommended by Leica Geosystems can destroy the batteries. This can cause fire or explosions.

**Precautions:**

Only use chargers recommended by Leica Geosystems to charge the batteries.

---

 **Warning**

High mechanical stress, high ambient temperatures or immersion into fluids can cause leakage, fire or explosions of the batteries.

**Precautions:**

Protect the batteries from mechanical influences and high ambient temperatures. Do not drop or immerse batteries into fluids.

---

 **Warning**

Short circuited battery terminals can overheat and cause injury or fire, for example by storing or transporting in pockets if battery terminals come in contact with jewelry, keys, metallized paper or other metals.

**Precautions:**

Make sure that the battery terminals do not come into contact with metallic objects.

---

 **Warning**

If the product is improperly disposed of, the following can happen:

- If polymer parts are burnt, poisonous gases are produced which may impair health.

- If batteries are damaged or are heated strongly, they can explode and cause poisoning, burning, corrosion or environmental contamination.
- By disposing of the product irresponsibly you may enable unauthorized persons to use it in contravention of the regulations, exposing themselves and third parties to the risk of severe injury and rendering the environment liable to contamination.
- Improper disposal of silicone oil may cause environmental contamination.

**Precautions:**

The product must not be disposed with household waste.

Dispose of the product appropriately in accordance with the national regulations in force in your country.

Always prevent access to the product by unauthorized personnel.

Product specific treatment and waste management information can be downloaded from the Leica Geosystems home page at <http://www.leica-geosystems.com/treatment> or received from your Leica Geosystems dealer.

---

## 6.6

### 6.6.1

## Laser Classification

### General

---

#### General

The following directions (in accordance with the state of the art - international standard IEC 60825-1 (2007-03) and IEC TR 60825-14 (2004-02)) provide instruction and training information to the person responsible for the product and the person who actually uses the equipment, to anticipate and avoid operational hazards.

The person responsible for the product must ensure that all users understand these directions and adhere to them.



Products classified as laser class 1, class 2 and class 3R do not require:

- laser safety officer involvement,
- protective clothes and eye wear,
- special warning signs in the laser working area

if used and operated as defined in this user manual due to the low eye hazard level.



Products classified as laser class 2 or class 3R may cause dazzle, flash-blindness and afterimages, particularly under low ambient light conditions.

---

## Labelling

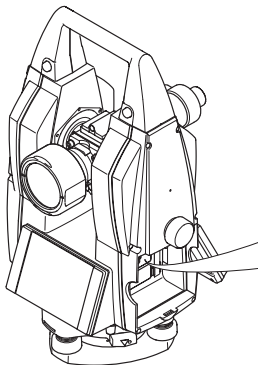
**Type: TM6100A**

Art.No.:

576372

Equip.No.: . . . . .

S.No.:

Power: 12V/14,8V ---, 2,5A max

. . . . .

Leica Geosystems AG

CH-9435 Heerbrugg

Manufactured: . . . .

Made in Switzerland



Complies with FDA performance standards for laser products except for deviations pursuant to Laser Notice No.50, dated June 24, 2007.

This device complies with part 15 of the FCC Rules.

Operation is subject to the following two conditions:

- (1) This device may not cause harmful interference, and
- (2) this device must accept any interference received, including interference that may cause undesired operation.

## 6.6.2

### Laser Plummet

---

#### General

The laser plummet built into the product produces a visible red laser beam which emerges from the bottom of the product.

The laser product described in this section, is classified as laser class 2 in accordance with:

- IEC 60825-1 (2007-03): "Safety of laser products"
- EN 60825-1 (2007-10): "Safety of laser products"

Class 2 laser products:

These products are safe for momentary exposures but can be hazardous for deliberate staring into the beam.

Description	Value
Maximum average radiant power	1.00 mW
Pulse duration	c.w.
Pulse repetition frequency	c.w.
Wavelength	620 nm - 690 nm

---

 **Warning**

From a safety perspective class 2 laser products are not inherently safe for the eyes.

**Precautions:**

Avoid staring into the beam or pointing the beam at other people.

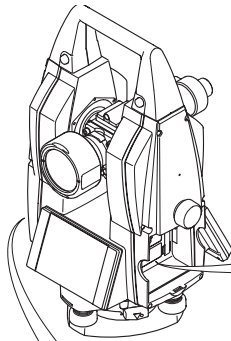
**Labelling**

Type: TM6100A

Art.No.:

Equip.No.: .....

576372

Power: 12V/14,8V $\overline{-}$ , 2,5A max

S.No.:

Leica Geosystems AG

.....

CH-9435 Heerbrugg

Manufactured: ....

Made in Switzerland



Complies with FDA performance standards for laser products except for deviations pursuant to Laser Notice No.50, dated June 24, 2007.

This device complies with part 15 of the FCC Rules.

Operation is subject to the following two conditions:

- (1) This device may not cause harmful interference, and
- (2) this device must accept any interference received, including interference that may cause undesired operation.



**Laser Radiation**  
Do not stare into the beam  
Class 2 Laser Product  
according to IEC 60825-1  
(2007-03)  
 $P_o \leq 1.00 \text{ mW}$   
 $\lambda = 620 - 690 \text{ nm}$

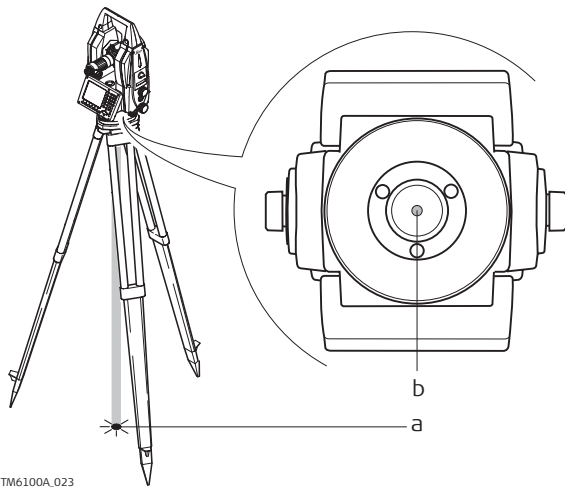

- a) Laser beam
- b) Exit for laser beam

## 6.7 Electromagnetic Compatibility EMC

---

### Description

The term Electromagnetic Compatibility is taken to mean the capability of the product to function smoothly in an environment where electromagnetic radiation and electrostatic discharges are present, and without causing electromagnetic disturbances to other equipment.

---

### Warning

Electromagnetic radiation can cause disturbances in other equipment.

Although the product meets the strict regulations and standards which are in force in this respect, Leica Geosystems cannot completely exclude the possibility that other equipment may be disturbed.

---

### Caution

There is a risk that disturbances may be caused in other equipment if the product is used in conjunction with accessories from other manufacturers, for example field computers, personal computers, two-way radios, non-standard cables or external batteries.

#### **Precautions:**

Use only the equipment and accessories recommended by Leica Geosystems. When combined with the product, they meet the strict requirements stipulated by the guidelines and standards. When using computers and two-way radios, pay attention to the information about electromagnetic compatibility provided by the manufacturer.

---



 **Caution**

Disturbances caused by electromagnetic radiation can result in erroneous measurements.

Although the product meets the strict regulations and standards which are in force in this respect, Leica Geosystems cannot completely exclude the possibility that the product may be disturbed by very intense electromagnetic radiation, for example, near radio transmitters, two-way radios or diesel generators.

**Precautions:**

Check the plausibility of results obtained under these conditions.

---

 **Warning**

If the product is operated with connecting cables attached at only one of their two ends, for example external supply cables, interface cables, the permitted level of electromagnetic radiation may be exceeded and the correct functioning of other products may be impaired.

**Precautions:**

While the product is in use, connecting cables, for example product to external battery, product to computer, must be connected at both ends.

---

**Radios or digital  
cellular phones****Warning**

Use of product with radio or digital cellular phone devices:

Electromagnetic radiation can cause disturbances in other equipment, in installations, in medical devices, for example pacemakers or hearing aids and in aircraft. It can also affect humans and animals.

**Precautions:**

Although the product meets in combination with radio or digital cellular phone devices recommended by Leica Geosystems the strict regulations and standards which are in force in this respect, Leica Geosystems cannot completely exclude the possibility that other equipment may be disturbed or that humans or animals may be affected.

- Do not operate the product with radio or digital cellular phone devices in the vicinity of filling stations or chemical installations, or in other areas where an explosion hazard exists.
  - Do not operate the product with radio or digital cellular phone devices near to medical equipment.
  - Do not operate the product with radio or digital cellular phone devices in aircraft.
  - Do not operate the product with radio or digital cellular phone devices for long periods immediately next to your body.
-

## 6.8

## FCC Statement, Applicable in U.S.

---

### Applicability

The greyed paragraph below is only applicable for products of the TM6100A System without radio, digital cellular phone devices or Bluetooth.

---



### Warning

This equipment has been tested and found to comply with the limits for a Class B digital device, pursuant to part 15 of the FCC rules. These limits are designed to provide reasonable protection against harmful interference in a residential installation.

This equipment generates, uses and can radiate radio frequency energy and, if not installed and used in accordance with the instructions, may cause harmful interference to radio communications. However, there is no guarantee that interference will not occur in a particular installation.

If this equipment does cause harmful interference to radio or television reception, which can be determined by turning the equipment off and on, the user is encouraged to try to correct the interference by one or more of the following measures:

- Reorient or relocate the receiving antenna.
  - Increase the separation between the equipment and the receiver.
  - Connect the equipment into an outlet on a circuit different from that to which the receiver is connected.
  - Consult the dealer or an experienced radio/TV technician for help.
-

 **Warning**

Changes or modifications not expressly approved by Leica Geosystems for compliance could void the user's authority to operate the equipment.

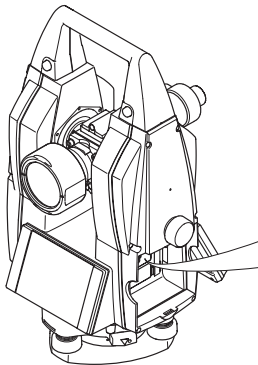
**Labelling**  
**TM6100A**

TM6100A\_024

**Type: TM6100A**

Art.No.:

576372

Equip.No.: . . . . .

S.No.:

Power: 12V/14,8V  $\approx$ , 2,5A max

. . . . .

Leica Geosystems AG

CH-9435 Heerbrugg

Manufactured: . . . .

Made in Switzerland



Complies with FDA performance standards for laser products except for deviations pursuant to Laser Notice No.50, dated June 24, 2007.

This device complies with part 15 of the FCC Rules.

Operation is subject to the following two conditions:

- (1) This device may not cause harmful interference, and
- (2) this device must accept any interference received, including interference that may cause undesired operation.

**Labelling  
internal battery  
GEB241**

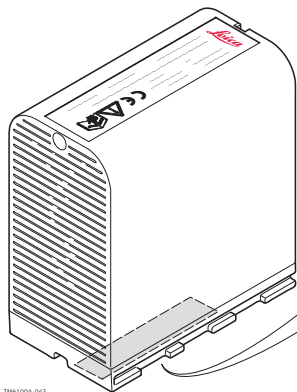

TM6100A\_043

This device complies with part 15 of the FCC Rules. Operation is subject to the following two conditions: (1) This device may not cause harmful interference, and (2) this device must accept any interference received, including



## 7 Technical Data

### 7.1 Angle Measurement

#### Accuracy

Type	Std. Dev. Hz, V, ISO 17123-3		Display least count	
	["]	[mgon]	["]	[mgon]
TM6100A	0.5	0.15	0.01	0.01

#### Characteristics

Absolute, continuous, quadruple

## 7.2

### 7.2.1

#### Conformity to national regulations

## Conformity to National Regulations

### Communication side cover with Bluetooth

- FCC Part 15 (applicable in US)
- Hereby, Leica Geosystems AG, declares that the Communication side cover with Bluetooth is in compliance with the essential requirements and other relevant provisions of Directive 1999/5/EC. The declaration of conformity may be consulted at <http://www.leica-geosystems.com/ce>.



Class 1 equipment according European Directive 1999/5/EC (R&TTE) can be placed on the market and be put into service without restrictions in any EU Member state.

- The conformity for countries with other national regulations not covered by the FCC part 15 or European directive 1999/5/EC has to be approved prior to use and operation.

#### Frequency band

2402 - 2480 MHz

#### Output power

Bluetooth: 5 mW

#### Antenna

Type Internal Microstrip antenna  
Gain 1.5 dBi

## 7.3

## General Technical Data of the Instrument

## Telescope

Type	Panfocal alignment telescope
Image	Erect
Objective aperture	52 mm
Clear objective diameter:	40 mm
Focusing:	Coarse and fine

## Field of view and magnification

Focussing distance	Field of view	Magnification	
		Standard Eyepiece	Eyepiece FOK53
$\infty$	1°08'	43 x	59 x
100 m	2.08 m	41 x	56 x
10 m	0.26 m	32 x	44 x
3 m	0.11 m	24 x	33 x
0.6 m	0.04 m	13 x	18 x



**Focussing distance**

<b>Shortest focussing distance</b>	<b>Distance [m]</b>
From telescope front lens	0.51
From telescope tilting axis	0.60

**Telescope tilt**

<b>Pointing direction</b>	<b>Vertical Angle</b>
Telescope pointing down	- 55° (-60 gon)
Telescope pointing up	+ 47° (+52 gon)

**Special features**

<b>Feature</b>	<b>Description</b>
Built-in autocollimation device	Green negative crosshair
Illumination	AL51 plug-in lamp, keyboard switch

**Compensator**

<b>Type</b>	<b>Setting accuracy</b>		<b>Setting range</b>	
	<b>["]</b>	<b>[mgon]</b>	<b>[']</b>	<b>[gon]</b>
TM6100A	0.5	0.15	4	0.07

**Level**

Compensation:

Centralized quadruple axis compensation

---

Circular level sensitivity:	6'/2 mm
Electronic level resolution:	2"

---

**Control unit**

Display:	1/4 VGA (320 x 240 pixels), color, graphics capable LCD, illumination, touch screen
Keyboard:	34 keys including 12 function keys, 12 alphanumeric keys and a user defined SmartKey, illumination
Angle Display:	360°", 360° decimal, 400 gon, 6400 mil, V %
Position:	Face I (optional both faces)
Touch screen:	Toughened film on glass

---

**Instrument Ports**

Port	Name	Description
Port 1	Port 1	<ul style="list-style-type: none"> <li>8 pin LEMO-1 for power, communication, data transfer.</li> <li>This port is located at the base of the instrument.</li> </ul>
Port 2	Handle	<ul style="list-style-type: none"> <li>Not applicable</li> </ul>
Port 3	BT	<ul style="list-style-type: none"> <li>Bluetooth module for communication.</li> <li>This port is housed within Communication side cover.</li> </ul>

---

## Instrument Dimensions

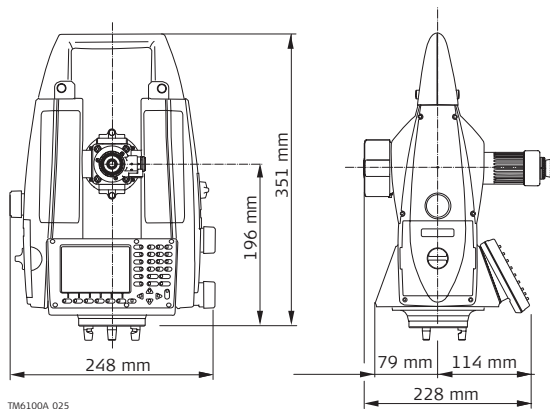

## Weight

---

Instrument:	7.25 kg
Tribrach:	0.8 kg
Internal battery GEB241:	0.43 kg

---

**Recording**

Data can be recorded onto a CompactFlash card or into internal memory.

Type	Capacity [MB]	Number of measurements per MB
CompactFlash card	• 256, 1024	1750
Internal memory	• 256	1750

**Laser plummet**

Type: Visible red laser class 2  
 Location: In standing axis of instrument  
 Accuracy: Deviation from plumbline:  
 1 mm at 1.5 m instrument height  
 Diameter of laser point: 2 mm at 1.5 m instrument height

**Operation**

Three endless drives: For one and two hand manual operation  
 User defined Smartkey: Fast precision triggerkey for manual high precision measurements

**Motorisation**

Maximum acceleration: 400 gon/s<sup>2</sup>  
 Maximum rotating speed: 200 gon/s  
 Time for change face: Typically 2.9 s

**Power**

External supply voltage: Nominal voltage 12.8 V DC, Range 11.5 V-13.5 V  
 Standby power consumption: Typically 5.9 W

---

**Internal battery**

Type:	Li-Ion
Voltage:	14.8 V
Capacity:	GEB241: 4.8 Ah
Typical operating time:	9 h

---

**External battery**

Type:	NiMH
Voltage:	12 V
Capacity:	GEB171: 9.0 Ah
Typical operating time:	12 - 18 h

---

**Environmental specifications****Temperature**

Type	Operating temperature [°C]	Storage temperature [°C]
TM6100A	-20 to +50	-40 to +70
Leica CompactFlash cards, all sizes	-40 to +80	-40 to +80
Battery internal	-20 to +50	-40 to +70
Bluetooth	-20 to +50	-40 to +70

**Protection against  
water, dust and  
sand**

Type	Protection
TM6100A	IP54 (IEC 60529)

**Humidity**

Type	Protection
TM6100A	Max 95 % non condensing The effects of condensation are to be effectively counter-acted by periodically drying out the instrument.

**Automatic  
corrections**

The following automatic corrections are made:

- Line of sight error
- Tilting axis error
- Circle eccentricity
- Compensator index error
- Vertical index error
- Standing axis tilt

## 8 International Limited Warranty, Software License Agreement

---

### **International Limited Warranty**

This product is subject to the terms and conditions set out in the International Limited Warranty which you can download from the Leica Geosystems home page at <http://www.leica-geosystems.com/internationalwarranty> or collect from your Leica Geosystems distributor.

The foregoing warranty is exclusive and is in lieu of all other warranties, terms or conditions, express or implied, either in fact or by operation of law, statutory or otherwise, including warranties, terms or conditions of merchantability, fitness for a particular purpose, satisfactory quality and non-infringement, all of which are expressly disclaimed.

---

### **Software License Agreement**

This product contains software that is preinstalled on the product, or that is supplied to you on a data carrier medium, or that can be downloaded by you online pursuant to prior authorization from Leica Geosystems. Such software is protected by copyright and other laws and its use is defined and regulated by the Leica Geosystems Software License Agreement, which covers aspects such as, but not limited to, Scope of the License, Warranty, Intellectual Property Rights, Limitation of Liability, Exclusion of other Assurances, Governing Law and Place of Jurisdiction. Please make sure, that at any time you fully comply with the terms and conditions of the Leica Geosystems Software License Agreement.

---

Such agreement is provided together with all products and can also be referred to and downloaded at the Leica Geosystems home page at <http://www.leica-geosystems.com/swlicense> or collected from your Leica Geosystems distributor.

You must not install or use the software unless you have read and accepted the terms and conditions of the Leica Geosystems Software License Agreement. Installation or use of the software or any part thereof, is deemed to be an acceptance of all the terms and conditions of such license agreement. If you do not agree to all or some of the terms of such license agreement, you may not download, install or use the software and you must return the unused software together with its accompanying documentation and the purchase receipt to the dealer from whom you purchased the product within ten (10) days of purchase to obtain a full refund of the purchase price.

---



<b>A</b>		<b>B</b>	
Abbreviations .....	8	Battery	
Acclimatise to the ambient temperature .....	63	For instrument .....	41
Accuracy		Icon .....	36
Angle measurement .....	110	Overview .....	40
Adjustment		Technical data GEB171 .....	117
Combined (I, t, i, c and ATR) .....	65	Technical data GEB241 .....	117
Electronic .....	60	Bluetooth, icon .....	36
Inspecting the laser plummet .....	77	<b>C</b>	
Mechanical .....	61	CE .....	21
Of circular level on instrument .....	74	Check & Adjust .....	60
Of circular level on prism pole .....	76	Cleaning and Drying .....	85
Of circular level on tribrach .....	74	Communication side cover .....	9
Of laser plummet .....	77	Technical data .....	111
Preparation .....	63	CompactFlash Card .....	13, 43
Titling axis (a) .....	69	Format card .....	45
Adjustment Errors		Icon .....	36
View current .....	61	Insert card .....	43
Angle Measurement .....	110	Remove card .....	43
Antenna		Safety instructions .....	43
Communication side cover .....	111	Compensator .....	113
Automatic Corrections .....	118	Container Contents	
		For instrument .....	16

Control unit .....	114	<b>F</b>	
Conversion, data conversion .....	14	FCC Statement .....	107
Corrections		Frequency Band	
Automatic .....	118	Communication side cover .....	111
<b>D</b>		<b>G</b>	
Data Conversion .....	13	GeoC++ Software Development Kit .....	12
Data Storage .....	13	GUS29 .....	19
Dimensions		<b>H</b>	
Of instrument .....	115	Hazards of Use .....	93
Documentation .....	4	<b>I</b>	
Drive		Icons	
OMNI .....	14	Overview .....	35
Drives .....	116	Instrument	
<b>E</b>		Dimensions .....	115
Edit		Ports .....	114
Value in input field .....	31	Technical data .....	112
Electromagnetic Compatibility EMC .....	104	Turn on and turn off .....	29
Electronic Adjustment .....	60	Weight .....	115
ENTER .....	22	Instrument Components .....	17
Environmental Specifications .....	117	Instrument Models .....	10
ESC .....	21	Instrument Setup	
		Conventional .....	37

Intended Use .....	89	LEICA Geo Office LGO Tools, description .....	8, 10
Internal Memory .....	13	Level .....	23, 113
Internal memory, icon .....	36	Lights .....	23
Internal target .....	19	Lock, keyboard .....	29
<b>K</b>		<b>M</b>	
Keyboard .....	20, 29	Maintenance .....	87
Locking and unlocking .....	29	Manual	
Operating principles .....	29	Validity of user manual .....	3
Keys .....	21	Mechanical Adjustment .....	61
Keys, Alphanumeric .....	21	Menu, selecting from a .....	30
Keys, Arrow .....	22	<b>O</b>	
Keys, Combinations .....	23	OMNI drive .....	14
Keys, Function .....	22	ON .....	21
Keys, Hot .....	21	Operation .....	116
<b>L</b>		Output Power	
Laser Classification .....	99	Communication side cover .....	111
Electronic Guide Light EGL .....	101	<b>P</b>	
Integrated Distancer, Invisible Laser .....	100	Page, selecting from a .....	30
Laser Plummet .....	101	Pages down .....	23
PowerSearch PS .....	101	Pages up .....	23
Laser Plummet		Ports .....	114
Adjustment .....	77	Power Supply .....	15
Technical data .....	116		

PowerSearch PS .....	111	Language software .....	11
Precise Measurements .....	61	Software type .....	11
PROG .....	21	Software upload .....	12
<b>Q</b>		System software .....	11
Quick coding, icon .....	36	Software Concept .....	11
Quick settings .....	23	Storage .....	84
<b>R</b>		Survey Application .....	46
Raw data transfer to LGO Tools .....	14	System Concept .....	11
Recording .....	116	<b>T</b>	
Reflectors .....	118	Technical Data .....	110
Responsibilities .....	92	Telescope .....	112
<b>S</b>		Telescope Protection Cushion .....	82
Safety Directions .....	88	Temperature	
Screen .....	27	Battery Internal	
Scroll bar, description .....	28	Operating .....	117
Service of tripod .....	79	Storage .....	117
Setup		Bluetooth	
Conventional .....	37	Operating .....	117
SHIFT .....	22, 36	Storage .....	117
Software		CompactFlash Card	
Application programs .....	12	Operating .....	117
Customised application programs .....	12	Storage .....	117
		Instrument	

Operating .....	117
Storage .....	117
Terminology .....	8
T-LINK .....	52
Touch Screen, operating principles .....	29
Transfer raw data to LGO Tools .....	14
Transport .....	82
Tripod, service of .....	79
 <b>U</b>	
Unlock, keyboard .....	29
USB Download Cable .....	53
USER .....	21
User Interface .....	20
 <b>V</b>	
Value, edit in input field .....	31
View Current Adjustment Errors .....	61
 <b>W</b>	
Weight	
Of instrument .....	115
 <b>Y</b>	
Y-Cable .....	53

**Total Quality Management: Our commitment to total customer satisfaction.**



Leica Geosystems AG, Heerbrugg, Switzerland, has been certified as being equipped with a quality system which meets the International Standards of Quality **Management** and Quality Systems (ISO standard 9001) and Environmental Management Systems (ISO standard 14001).

**Ask your local Leica Geosystems dealer for more information about our TQM program.**

**Leica Geosystems AG**

Heinrich-Wild-Strasse  
CH-9435 Heerbrugg  
Switzerland  
Phone +41 71 727 31 31

[www.leica-geosystems.com](http://www.leica-geosystems.com)

- when it has to be **right**

**Leica**  
**Geosystems**

**781366-1.0.2en**

Original text  
Printed in Switzerland © 2009 Leica Geosystems AG, Heerbrugg, Switzerland